

**READYGLASS**

---

**PRODUCT CATALOG**



## About us - about Ready Glass

---

Two colleagues are the originators of the concept and designers of ready-made architectural products combining glass and metal under the banner of Ready Glass. Their engineering, architectural and commercial experience turned out to be a great combination. Thanks to this fusion of knowledge and skills, we can offer high-quality, refined products. We stand out both in terms of technology and safety, as well as the highest experience of our satisfied customers who decide to buy glass canopies, doors or balustrades in Ready Glass.

## Contacts - the source of the best materials

---

The network of international contacts that we have managed to create over the years allows us to order the best, quality materials. Experience in the technological field allowed for professional and accurate selection of the contractors for Ready Glass products. This gives us the opportunity to build trust with contractors and an advantage over companies that only re-distribute finished products.

## Insight into the highest quality of Ready Glass

---

We personally supervise the entire production process of glass canopies, balustrades or doors made of glass. We want to be sure that the products with the Ready Glass logo will meet the expectations of our customers in 100%. Thanks to this, we can recommend our products with full awareness and be sure that they will be used without problems for years by satisfied customers.



# ReadyGlass canopy - types

## System Hanger glaving on the tension members



120 x 90 cm



150 x 90 cm

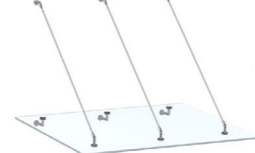

160 x 120 cm

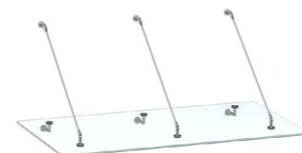

180 x 90 cm

## Rail System glass canopy attached directly to the wall



140 x 100 cm



160 x 100 cm



180 x 100 cm



200 x 100 cm



**Bracket System „I”**  
glass canopy on a bracket  
with the cross-section „I”,  
cutout type „Slim”



120 x 90 cm



150 x 90 cm



180 x 90 cm

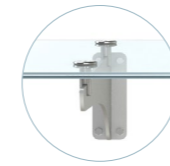

**Bracket System „I”**  
glass canopy on a bracket  
with the cross-section „I”,  
cutout type „Circle”



120 x 90 cm



150 x 90 cm



180 x 90 cm



**Bracket System „I”**  
glass canopy on a bracket  
with the cross-section „I”,  
cutout type „Solid”



120 x 90 cm



150 x 90 cm



180 x 90 cm

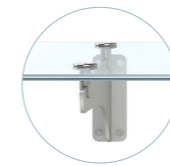

**Bracket System „I”**  
glass canopy on a bracket  
with the cross-section „I”,  
cutout type „Triangle”



120 x 90 cm



150 x 90 cm



180 x 90 cm

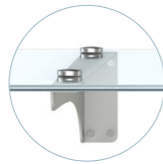

**Bracket System „L”**  
glass canopy on a bracket  
with the cross-section „L”,  
cutout type „Slim”



120 x 90 cm



150 x 90 cm

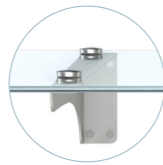

**Bracket System „L”**  
glass canopy on a bracket  
with the cross-section „L”,  
cutout type „Circle”



120 x 90 cm



150 x 90 cm

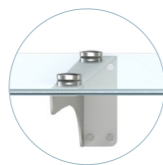

**Bracket System „L”**  
glass canopy on a bracket  
with the cross-section „L”,  
cutout type „Solid”



120 x 90 cm



150 x 90 cm

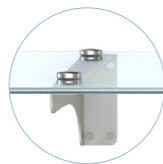

**Bracket System „L”**  
glass canopy on a bracket  
with the cross-section „L”,  
cutout type „Triangle”



120 x 90 cm



150 x 90 cm

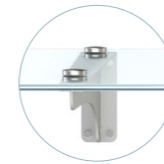

**Bracket System „T”**  
glass canopy on a bracket  
with the cross-section „T”,  
cutout type „Slim”



120 x 90 cm



150 x 90 cm



180 x 90 cm

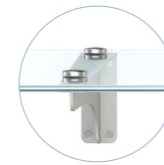

**Bracket System „T”**  
glass canopy on a bracket  
with the cross-section „T”,  
cutout type „Circle”



120 x 90 cm



150 x 90 cm



180 x 90 cm

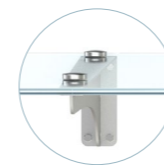

**Bracket System „T”**  
glass canopy on a bracket  
with the cross-section „T”,  
cutout type „Solid”



120 x 90 cm



150 x 90 cm



180 x 90 cm

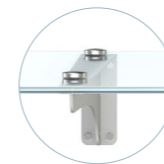

**Bracket System „T”**  
glass canopy on a bracket  
with the cross-section „T”,  
cutout type „Triangle”



120 x 90 cm



150 x 90 cm



180 x 90 cm

# Hanger System

## Glass canopy - Hanger System

**Glass canopy 120cm x 90cm - Hanger System**  
Glass canopy with dimensions of 120cm x 90cm.  
Made in the hanger system - anchored to the wall  
with a set of fittings and stainless steel tendons.

**Design and quality of Ready Glass**  
The glass canopy made in the Hanger system by Ready Glass is a high-quality element of the building facade that fulfills two key functions - protective (against weather conditions) and decorative (as a modern detail emphasizing the modern shape of the building).

**Glass**  
The highest quality glass used in the production of ReadyGlass glass canopies is toughened and glued, which makes it safe. The thickness of the glass pane is from 13.52 mm to even 17.52 mm for larger surfaces. The glass is available in three color variants: milky, transparent and graphite

**Contents of the package**

- canopy made of tempered safety glass
- a set of fasteners
- a set of anchors for assembly
- installation instructions

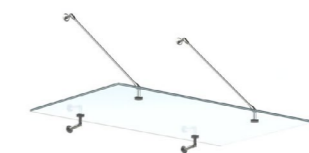
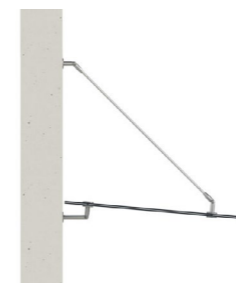

**Other variants of this system**  
The Hanger System from Ready Glass is available in four different sizes (width x depth):

- 120 cm x 90 cm,
- 150 cm x 90 cm,
- 180 cm x 90 cm,
- 160 cm x 120 cm

**Assembly and maintenance**  
Information on the installation, maintenance and cleaning of the glass canopy made in the Hanger System is included in the instructions attached to the product.

# Hanger System - dimensions

**Hanger System**  
120cm x 90cm

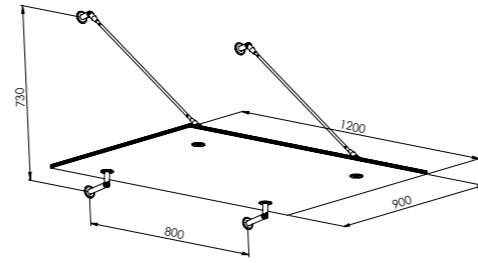

**Hanger System**  
150cm x 90cm

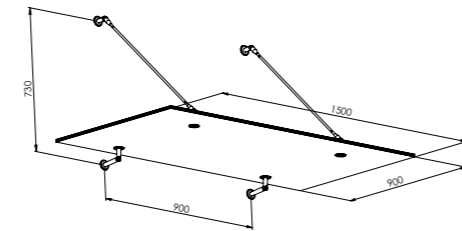

**Hanger System**  
180cm x 90cm

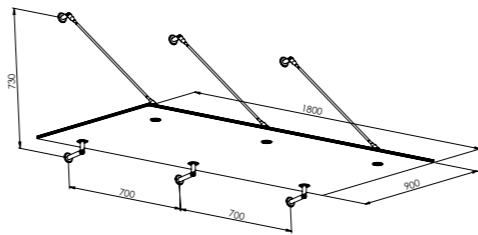
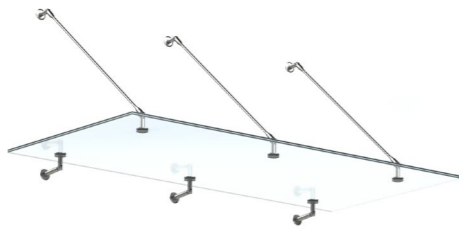

**Hanger System**  
160cm x 120cm

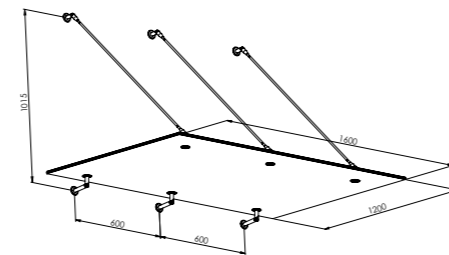
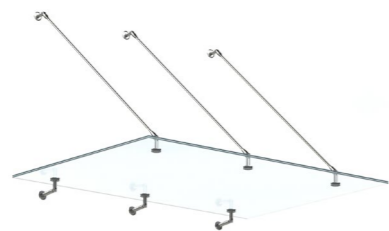

# Bracket System

# Glass canopy - Bracket System

## Glass canopy 120cm x 90cm - Bracket System

Glass canopy with dimensions of 120cm x 90cm. Made in the Bracket system - the glass pane is placed on brackets anchored to the facade surface. The photo shows a „Slim” shaped bracket and an „I” cross section. You will see more options on the following pages of the catalog.

## Design and quality of Ready Glass

The glass canopy made in the Bracket system by Ready Glass is a high-quality element of the building facade that fulfills two key functions - protective (against weather conditions) and decorative (as a modern detail emphasizing the modern shape of the building).

## Contents of the package

- canopy made of tempered safety glass
- a set of fasteners
- a set of anchors for assembly
- installation instructions

## Glass

The highest quality glass used in the production of ReadyGlass glass canopies is toughened and glued, which makes it safe. The thickness of the glass pane is from 13.52 mm to even 17.52 mm for larger surfaces. The glass is available in three color variants: milky, transparent and graphite



## Other variants of this system

The Hanger System from Ready Glass is available in four different sizes (width x depth):

- 120 cm x 90 cm,
- 150 cm x 90 cm,
- 180 cm x 90 cm,
- 160 cm x 120 cm

## Assembly and maintenance

Information on the installation, maintenance and cleaning of the glass canopy made in the Hanger System is included in the instructions attached to the product.

# Bracket System - configuration

## Make it your own

The Bracket System offers great configuration options and an individual approach to the subject of glass canopies. In order to configure the roof, four elements should be selected: the size and colour of the glass pane, the type of bracket and the type of cutout.

### Step 1

Choose the size of the glass from 120cm x 90cm to 180cm wide

### Step 2

Choose the color of the glass pane (you can choose milk, transparent or graphite)

### Step 3

Select the type of bracket („I”, „L” or „T” shaped section)

**Bracket System „I”**  
glass canoping on a bracket with the cross-section „I”

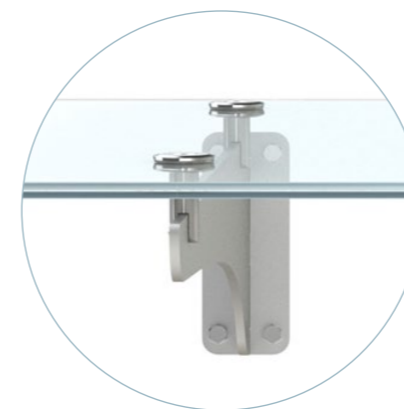

**Bracket System „L”**  
glass canoping on a bracket with the cross-section „L”

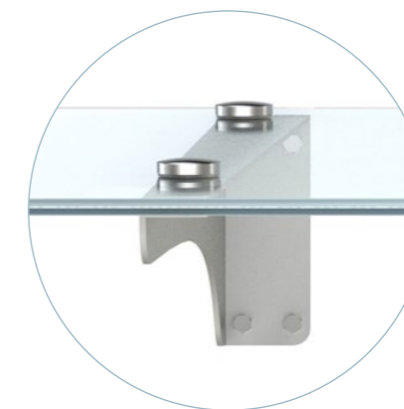

**Bracket System „T”**  
glass canoping on a bracket with the cross-section „T”

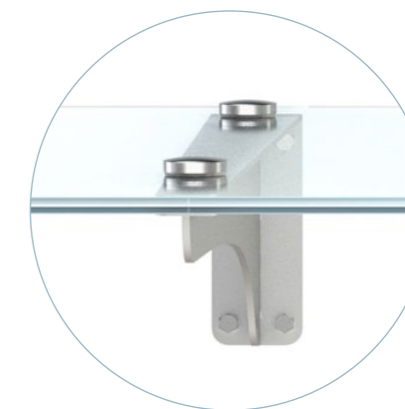

### Step 4

Final step is to choose cutout of bracket (four available cutouts)

**Circle shape**  
Bracket with circular cutouts



**Slim shape**  
A bracket with a delicate, slender and narrow shape



**Solid shape**  
A full bracket with a popular, modern shape



**Triangle shape**  
Lightweight bracket with a triangle-shaped cutout



## Bracket System - materials

### Materials from which the Ready Glass brackets are made

Ready Glass offers several types of materials from which the brackets are made. You can choose between polished stainless steel, brushed stainless steel or powder coated carbon steel in any color from the RAL palette.

## Bracket System „I” - dimensions

**Bracket System „I”**  
Solid shape  
120cm x 90cm

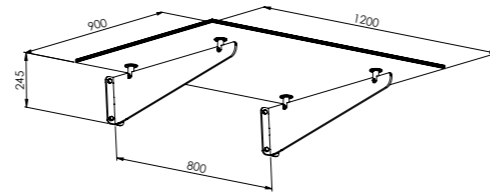

**Bracket System „I”**  
Solid shape  
150cm x 90cm

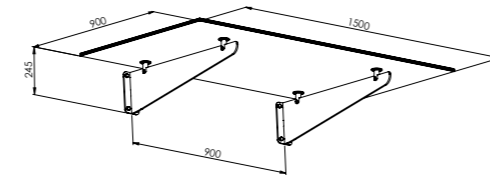

**Bracket System „I”**  
Solid shape  
180cm x 90cm

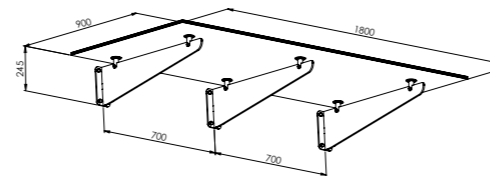

## Bracket System „L” - dimensions

**Bracket System „L”**  
Solid shape  
120cm x 90cm

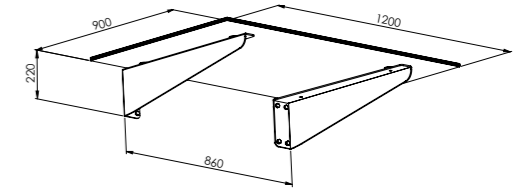

**Bracket System „L”**  
Solid shape  
150cm x 90cm

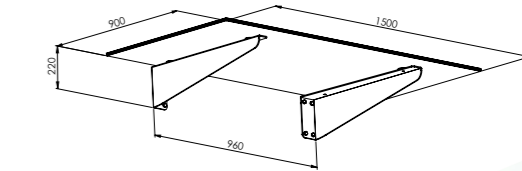



## Bracket System „T” - dimensions

**Bracket System „T”**  
Solid shape  
120cm x 90cm

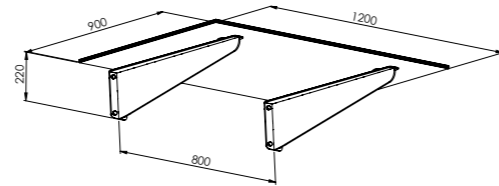

**Bracket System „T”**  
Solid shape  
150cm x 90cm

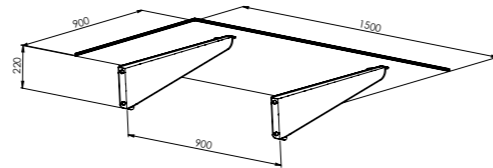

**Bracket System „T”**  
Solid shape  
180cm x 90cm

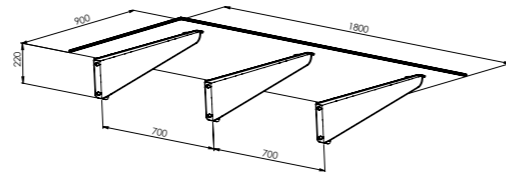

## Rail System

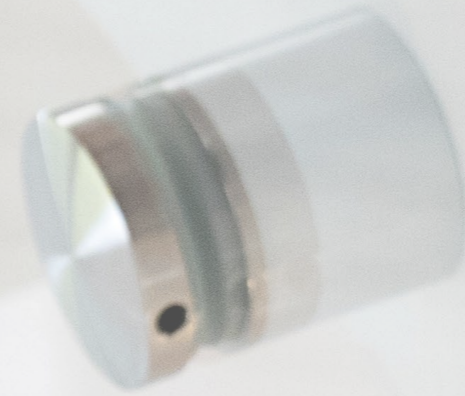

# Glass canopy - Rail System

## Self Supporting Canopy System

ReadyGlass Aluminium Self Supporting Canopy System will give any entrance an uncomplicated, graceful look. With the use of tempered laminated glass you can add a range of glass colors, textures, and special effects not available with typical monolithic glass.

## Design and quality of Ready Glass

This complements and enhances the design of any building. Self supporting aluminium profile, holds the glass with a special fitting which comes with profile. Connector rods are not required and you can install numerous profiles to extend the canopy in desired length.

## Contents of the package

- canopy made of tempered safety glass
- a set of fasteners
- a set of anchors for assembly
- installation instructions

## Glass

The highest quality glass used in the production of ReadyGlass glass canopies is toughened and glued, which makes it safe. The thickness of the glass pane is from 13.52 mm to even 17.52 mm for larger surfaces. The glass is available in three color variants: milky, transparent and graphite.

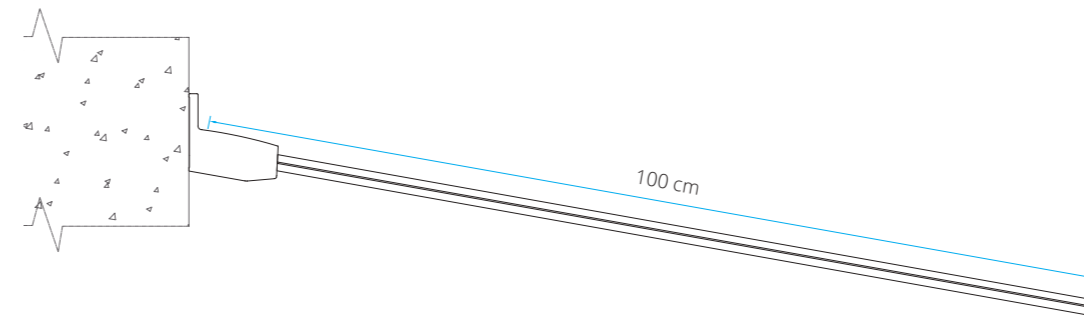

## Other variants of this system

The Hanger System from Ready Glass is available in four different sizes (width x depth):

- 140 cm x 100 cm,
- 160 cm x 100 cm,
- 180 cm x 100 cm,
- 200 cm x 100 cm

## Assembly and maintenance

Information on the installation, maintenance and cleaning of the glass canopy made in the Hanger System is included in the instructions attached to the product.



### Step 1

Mount the aluminium profile with appropriate fastening material to the wall.



### Step 2

Fit the edge protection rubber onto the glass and then insert the glass into the aluminium profile.

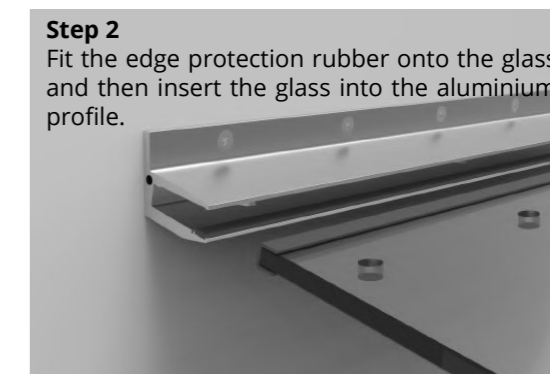

### Step 3

Align the glass panel and secure it with glass fixings.

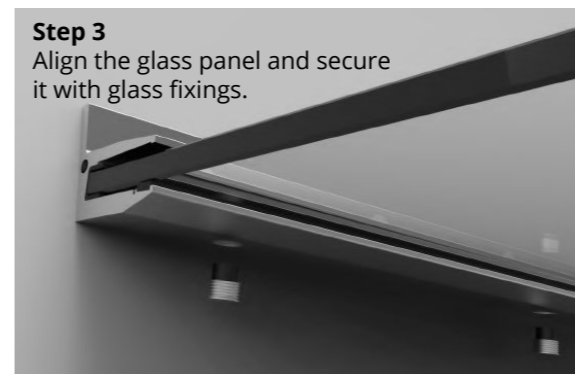

### Step 4

Place the endcaps on the profile and secure them with screws.

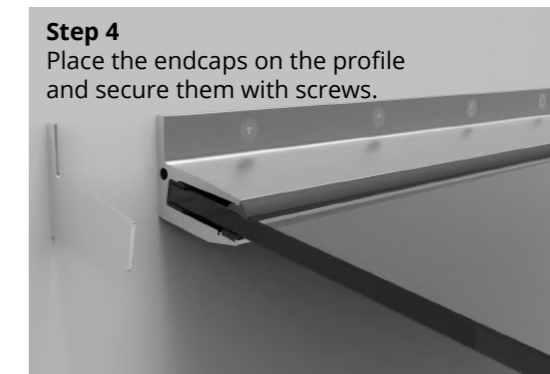

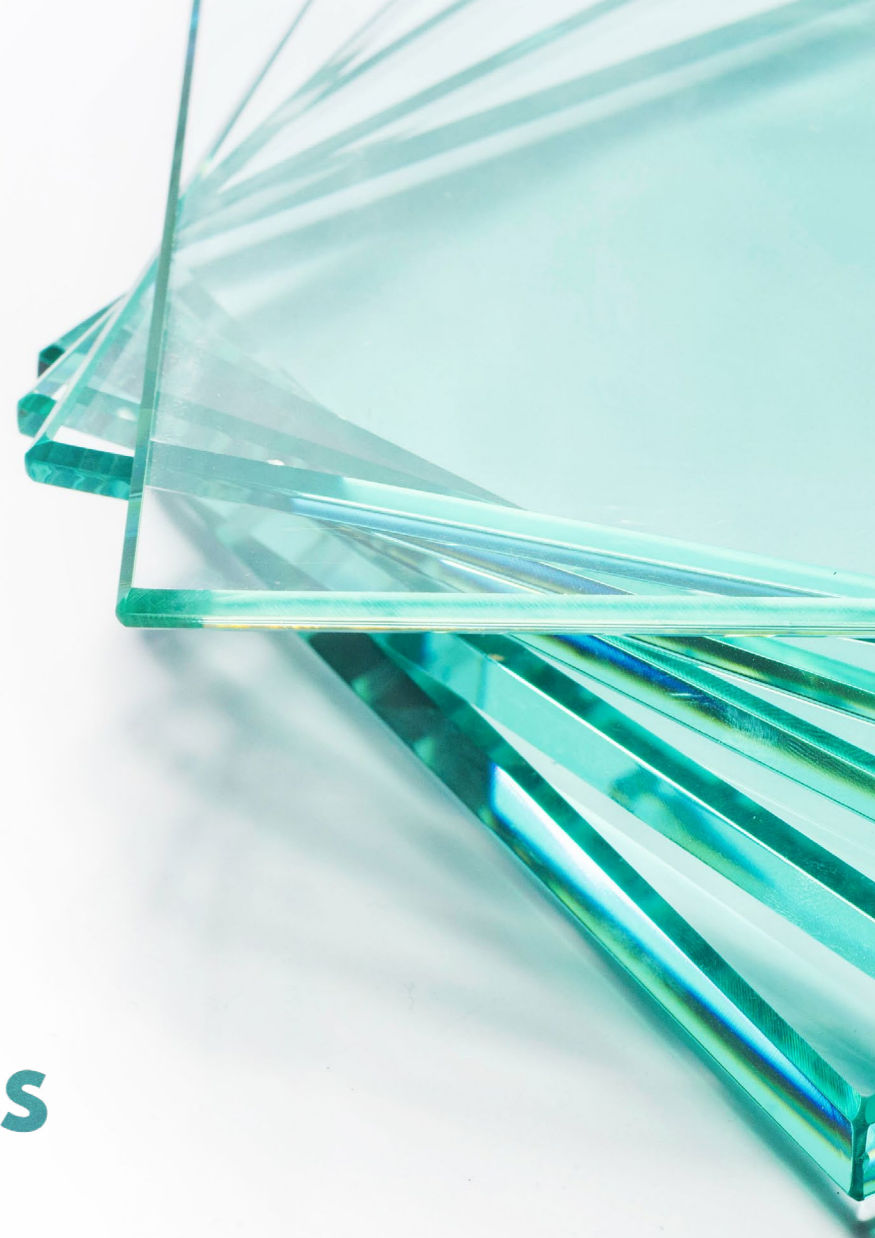

**ReadyGlass Sp. z o.o.**

**lokalizacja**

**e-mail:** [biuro@readyglass.pl](mailto:biuro@readyglass.pl)

**tel.:** +48 22 123 45 67

**mobile:** +48 123 456 789